

*Dart 18*



***DART 18***  
***RIGGING MANUAL***

## **DART 18 RIGGING MANUAL**

The DART 18 rigging instructions are a comprehensive guide to rigging your DART 18. Due to production supplies certain parts may be slightly modified from those shown. This instruction manual is not a guide to sailing your craft and should not be considered as suitable for the purpose of learning to sail a catamaran.

## **CAT. CLINIC (Dart Catamaran Sailing School)**

The Cat. Clinic is the Laser Centres' only recommended catamaran sailing school. Here you will find the most up to date DART CATAMARANS ready for your instruction. Catamaran enthusiasts of all abilities attend courses regularly to improve their technique. Further details of the Cat. Clinics' Centres can be obtained from

The "CAT. CLINIC"  
MYLOR YACHT HARBOUR,  
FALMOUTH, CORNWALL TR11 5UF  
Telephone number 0326 76191  
Fax 0326 76192

### **RECOMMENDED BOOKS**

Catamarans are one of the fastest craft on the water. So that you can enjoy your catamaran to its full potential we recommend 'The Catamaran Book' by Brian Phipps as a valuable addition to your library.

## **CONTENTS**

GLOSSARY	2
RIGGING INSTRUCTIONS	3
ACCESSORIES	16
GENERAL MAINTENANCE AND SERVICE	16
BASIC SAFETY AFLOAT	17

## GLOSSARY

**Aft:** towards the back of the boat.

**Bow:** the foremost end of the boat.

**Burgee:** a flag normally flown from the top of a mast.

**Batten:** a thin plastic strip which fits into a long narrow pocket in the sail.

**Bridle wire:** one of the two wires connected to the bow and forstay on a catamaran.

**Clew:** the lower after-most corner of a sail.

**Foot:** the bottom edge of the sail.

**Forward:** towards the bows of a boat.

**Forestay:** the wire supporting the mast in a fore and aft direction.

**Gunwale:** the outermost edge of the craft.

**Head:** the top corner of a sail.

**Hounds:** the connecting point on the mast for rigging that gives it support.

**Halyard:** a rope or wire used to hoist or lower sails.

**Jib sheet:** the rope used to control the position of the jib when under sail.

**Leech:** the trailing edge of a sail.

**Leeward:** the side of the boat on which the mainsail is set when sailing.

**Luff:** the front edge of a sail.

**Main sheet:** the rope controlling the position of a main sail.

**Mast heel:** the casting at the base of the mast.

**Port:** the left-hand side of a craft looking forward.

**Shroud:** a wire securing the mast in position and preventing it from falling sideways.

**Shackle:** a 'U' shaped piece of metal secured with a pin, used for securing halyards to sails etc.

**Starboard:** the right-hand side of a craft looking forward.

**Stern:** the aft-most area of a boat.

**Tack:** the lower forward corner of a sail.

**Tiller:** a length of aluminium which fits into the rudder head to allow steerage.

**Tiller extension:** a length of aluminium connected to the tiller by a universal joint which allows steerage whilst leaning out.

**Trapeze wire:** a wire used to extend the body beyond the gunwale of the boat.

**Transom:** the flat area across the back of the boat to which the rudder is hung.

**Windward:** the side of the boat opposite to which the mainsail is set when sailing.

1. Bow
2. Stern
3. Port hull
4. Stbd. hull
5. Mast
6. Burgee
7. Forestay
8. Bridle wires
9. Port shroud
10. Stbd. shroud
11. Mainsail
12. Jib
13. Battens x 9
14. Main beam
15. Rear beam
16. Port rudder
17. Stbd. tiller arm
18. Connecting bar
19. Tiller extension
20. Main sheet
21. Jib sheet
22. Downwind indicator

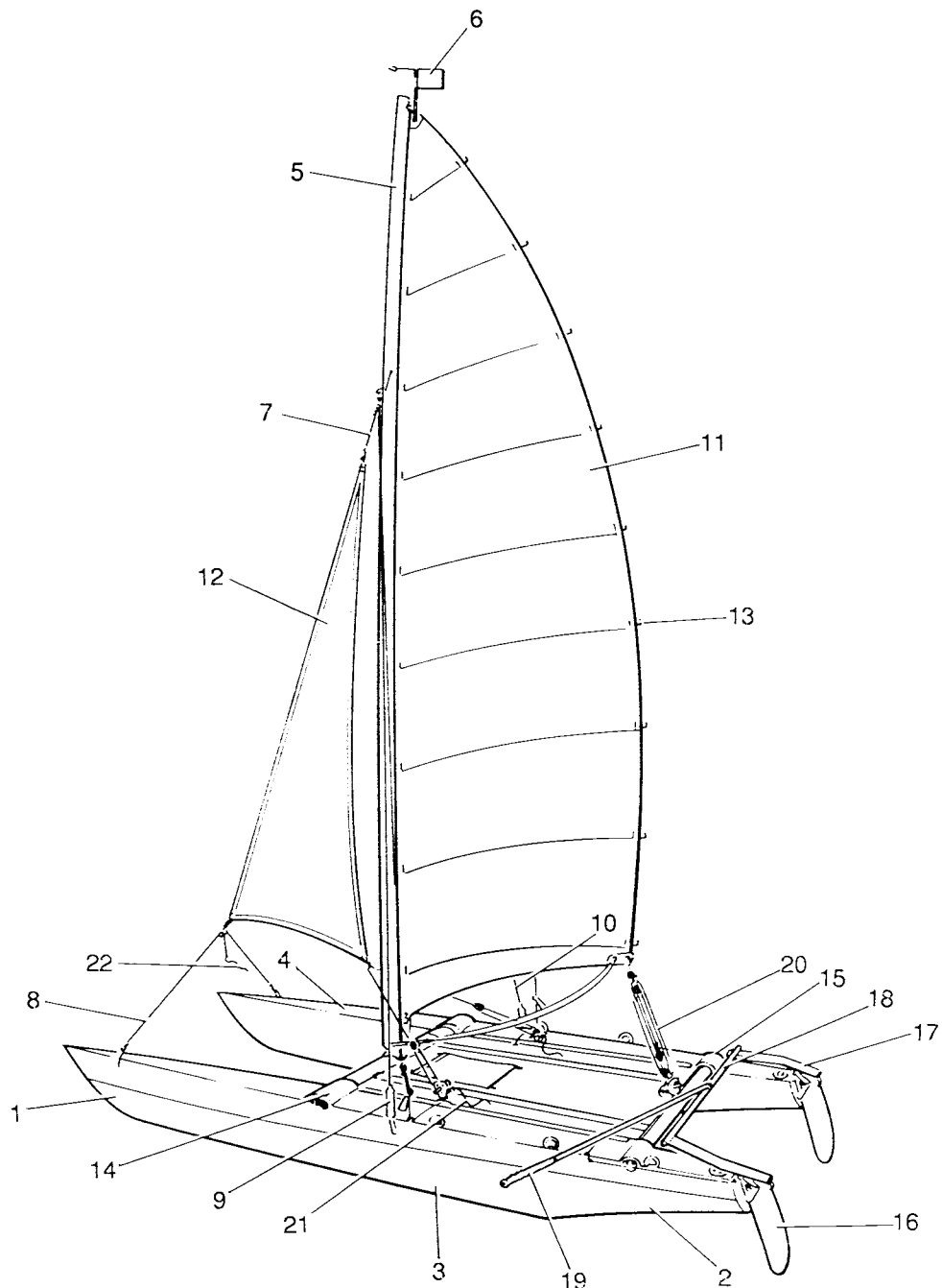

## RIGGING INSTRUCTIONS DART 18

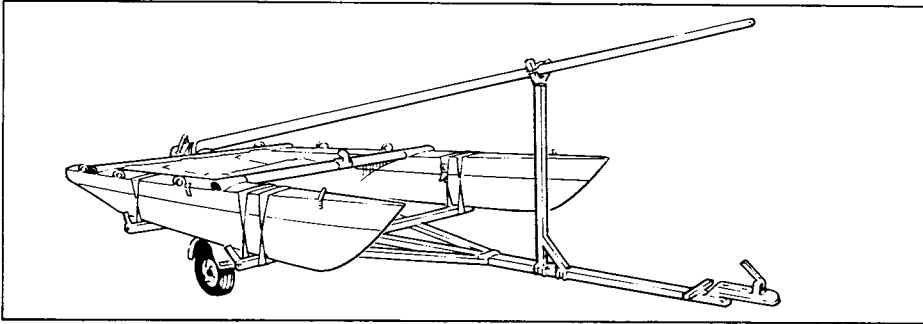

### REMOVING CATAMARAN FROM TRAILER

1. Trailer (towing assembled).

- \* Remove all securing straps.
- \* Remove spars, sails and other equipment.
- \* Place launching trolley at back of trailer under hulls.
- \* Pull the boat back until the keels rest on the launching trolley cups.
- \* Lift the bow and wheel the craft backwards.
- \* Lay out all parts of the boat and identify with the contents list.

2. Trailer (towing broken down)

- \* Remove all securing straps.
- \* Remove spars, sails and other equipment.
- \* Slide each hull off its securing rack and place on ground using suitable protection.
- \* Lay out all parts of boat and identify with contents list. (Fig 1)▶

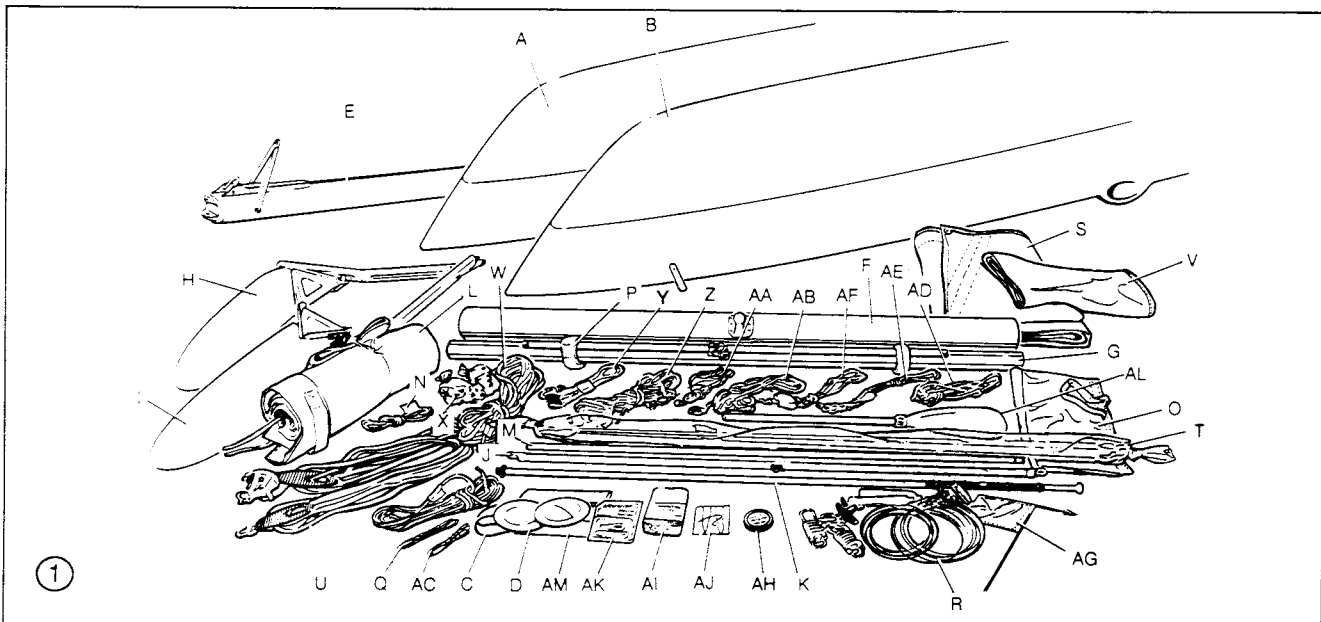
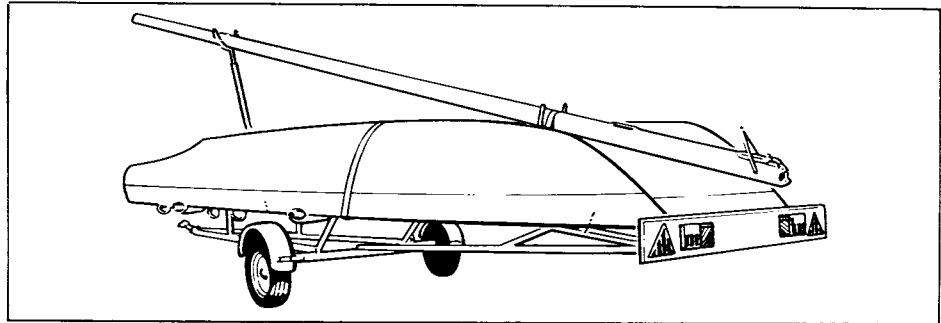

A	Port hull	K	Tiller extension	U	Main sheet system	AF	Spanner line
B	Starboard hull	L	Trampoline	V	Jib	AG	Burgee
C	'O' Rings x 2	M	Trampoline tube	W	Jib sheet	AH	Adhesive tape
D	Hatch covers x 2	N	Trampoline lacing line	X	Jib sheet block x 2	AI	Sponge
E	Mast	O	Trampoline satchel	Z	Main Halyard	AJ	Wind indicator
F	Main beam	P	Toe straps	AA	Main sail down haul	AK	Knife/shackle key
G	Rear beam	Q	Forestay line	AB	Jib Halyard	AL	Paddle
H	Port rudder	R	Standing rigging	AC	Jib down haul line	AM	Instructional manual/sail numbers
I	Starboard rudder	S	Main sail	AD	Traveller line		
J	Connecting bar	T	Main sail battens x 9	AE	Restraining line x 2		

**RIGGING DART 18**

- \* Place the hulls on a flat area of ground approx. 3 metres apart with the trampoline track facing upper most, (Fig 2)▼. (If a suitable area is unavailable use 4 tyres or similar to protect your craft).
- \* Select the main beam, Part F. (NB check that mast ball faces the deck before insertion).
- \* Slide the beam into the housing of one hull until the thrust pad meets the hull (Fig 3)▲
- \* Select the rear beam, Part G. (NB check that traveller track faces the deck before insertion).

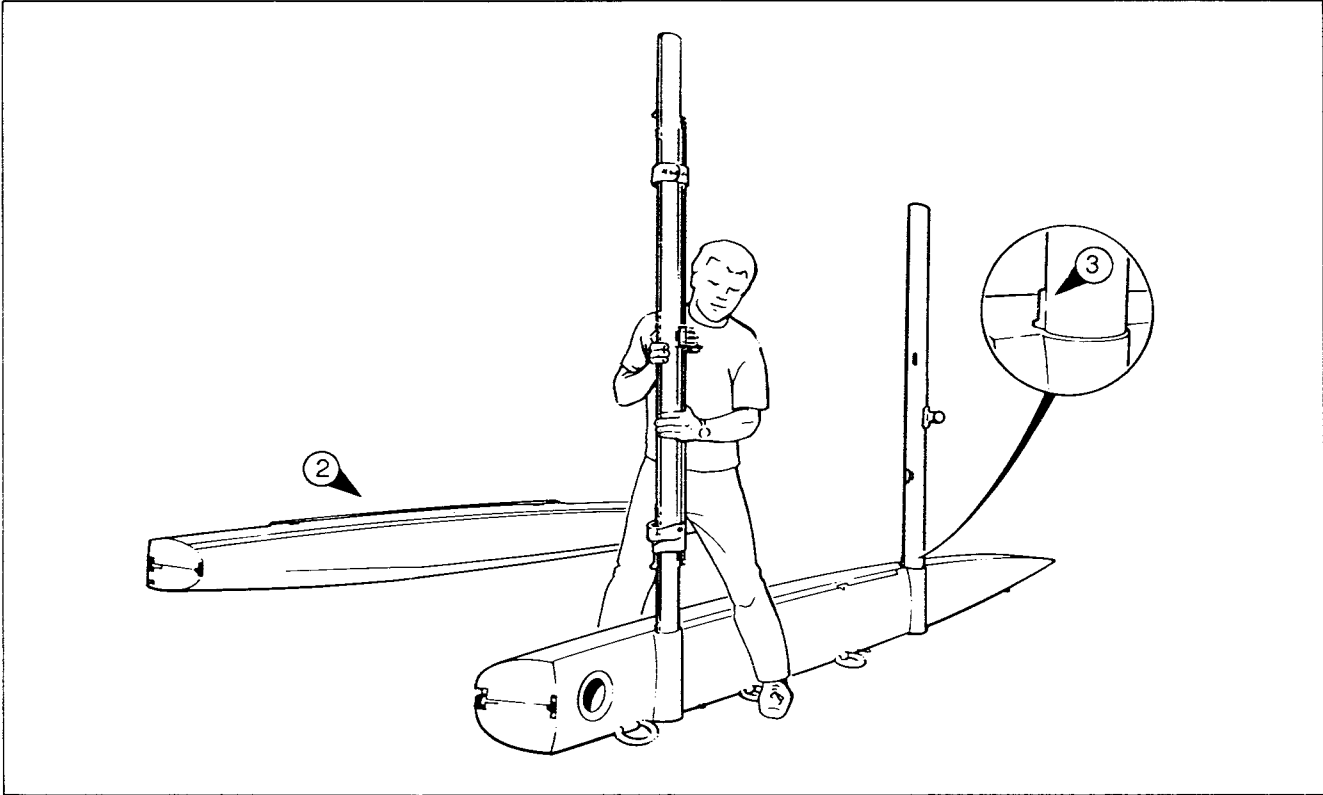

- \* Raise the retaining clip at the beam end by pressing the spring to one side (Fig 4)►. Insert the rear beam into its housing and slide home until the thrust pad meets the hull. Check that the retaining clip has dropped over the outer edge of the hull (Fig 5)▲
- \* Should the rear beam clips need adjusting, slacken the adjuster nut and retension to ensure a tight fit.
- \* Carefully pull the beams down to the horizontal position.
- \* Raise the unattached hull and line up with the beam housing.
- \* Slide the new hull onto the beams making sure that the hull is moved in a parallel action. The hull is fully home when the thrust pads are against the inner hull side and the rear beam clip has dropped over the outer edge (Fig 6)▲

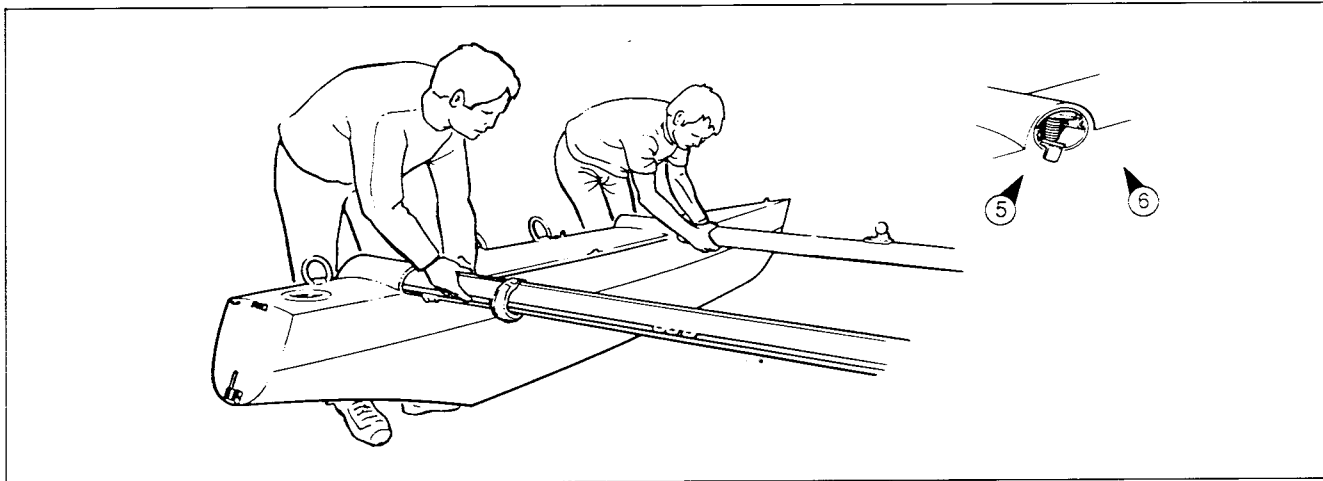
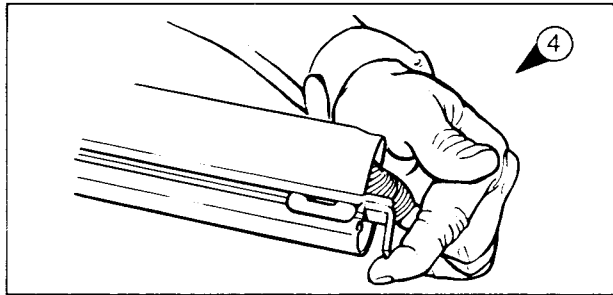

## ADDING THE TRAMPOLINE

- \* Identify the trampoline, Part L, and lay it between the hulls with the webbing handles facing down.
- \* Identify the front edge and insert the bolt rope into the main beam as shown (Fig 7)▼. (Check the trampoline is in the centre of the beam).

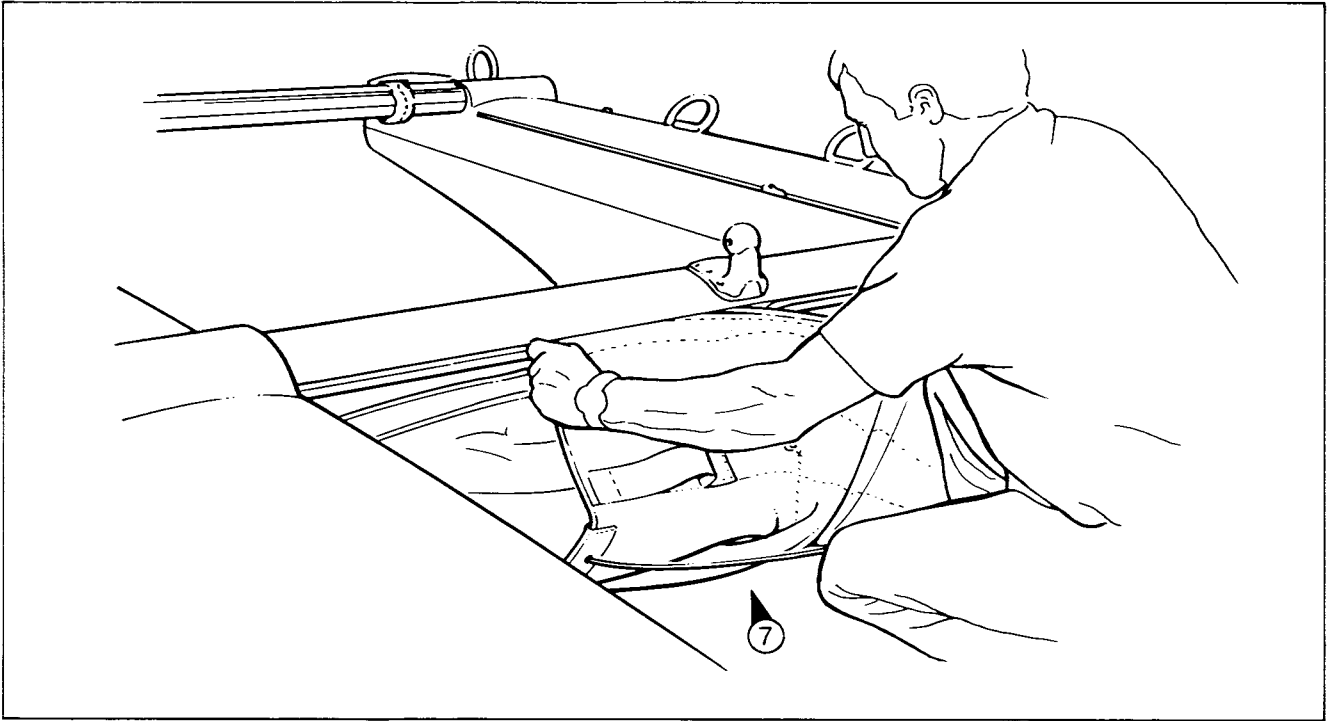

- \* Take the side bolt ropes and slide them into the trampoline track on both hulls (Fig 8)▶

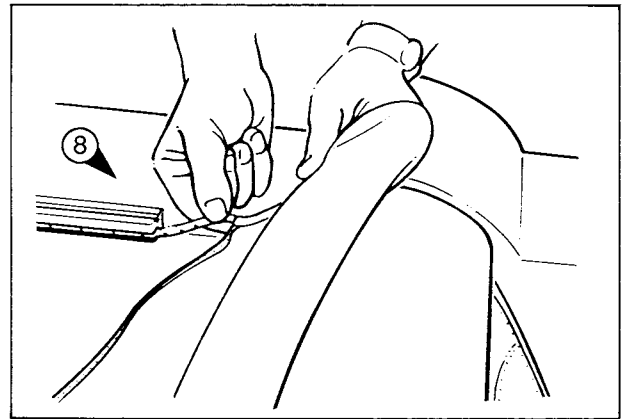

- \* Carefully slide the trampoline back along the tracks an equal amount until fully inserted in the track (Fig 9)▲
- \* Feed the trampoline tube, Part M, into the sleeve at the back of the trampoline and push the loose ends of the trampoline bolt ropes into either end (Fig 10)▼.

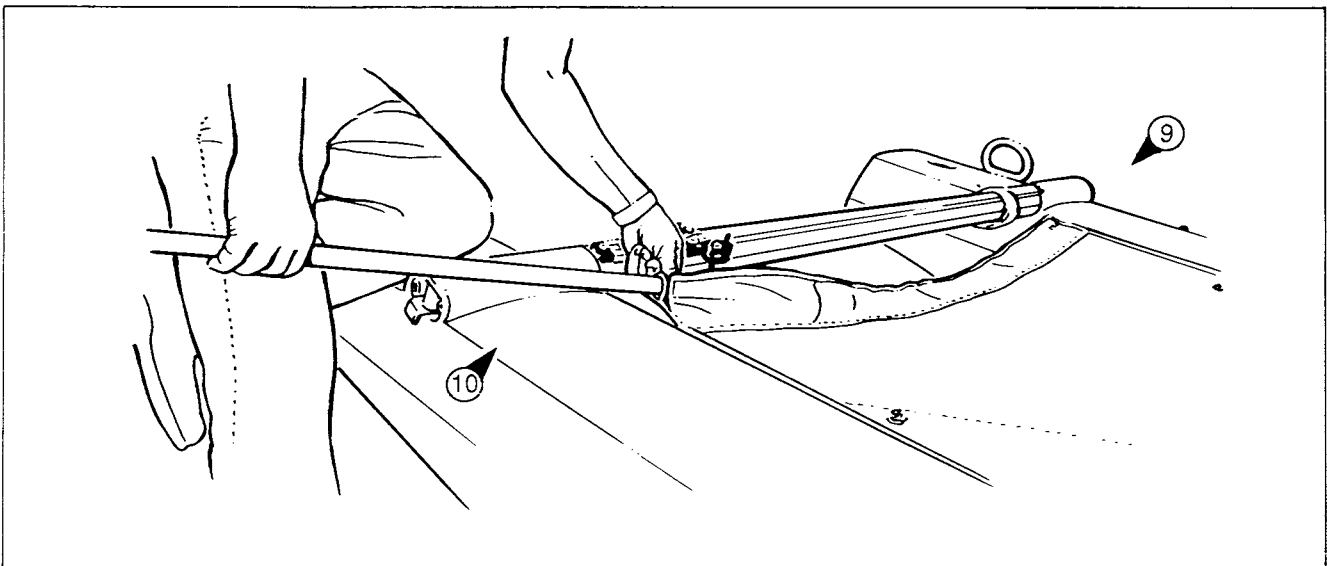

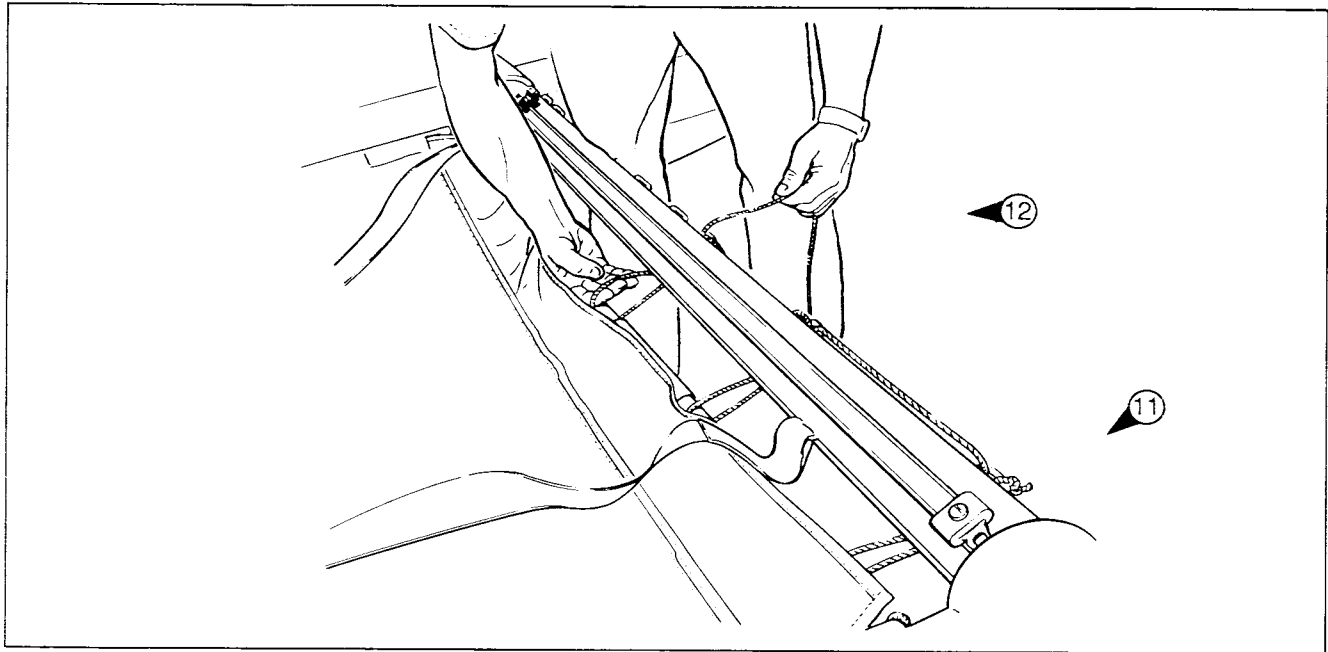

- \* Identify the trampoline lacing line, Part N, and tie it to the outer beam slide (Fig 11)▼
- \* Lace the trampoline (Fig 12)▼ making sure that the slides are opposite the trampoline cut-outs and that the centre slide is not used.
- \* Tension the trampoline and secure with a suitable knot. (You may find when the trampoline is new it will need several attempts to achieve the maximum tension. This is best carried out immediately after sailing) (Fig 13)▼.

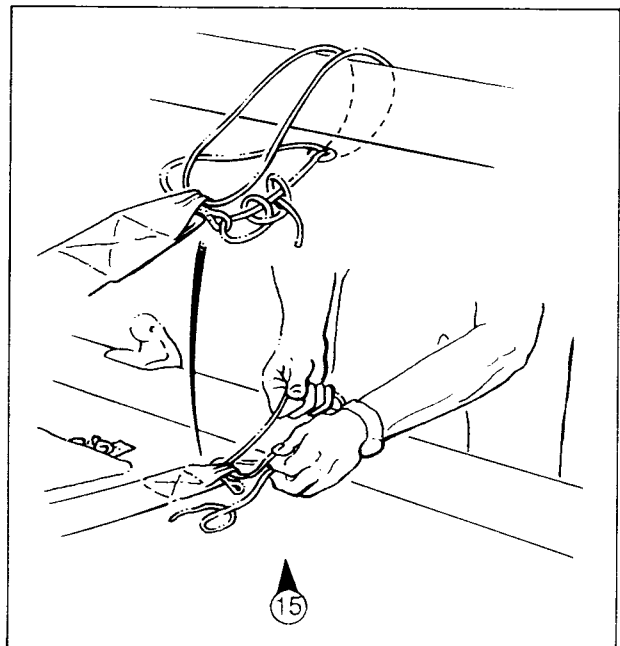
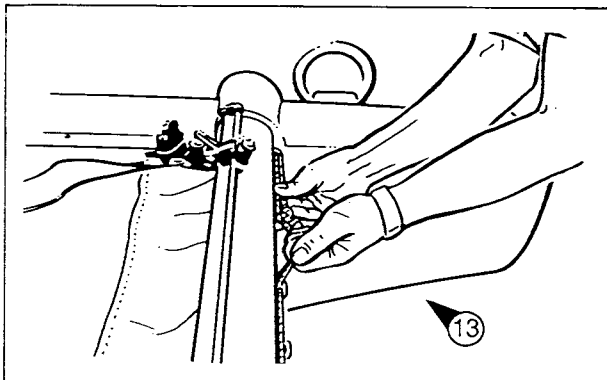

- \* Identify the trampoline satchel, Part O, and secure to the trampoline via the clips as shown (Fig 14)▼. The lower pocket is for excess halyard line, the inner pocket for other equipment such as paddle sponge and personal effects.

- \* Identify the toe straps, Part P, and secure them to the front beam as shown (Fig 15)▲

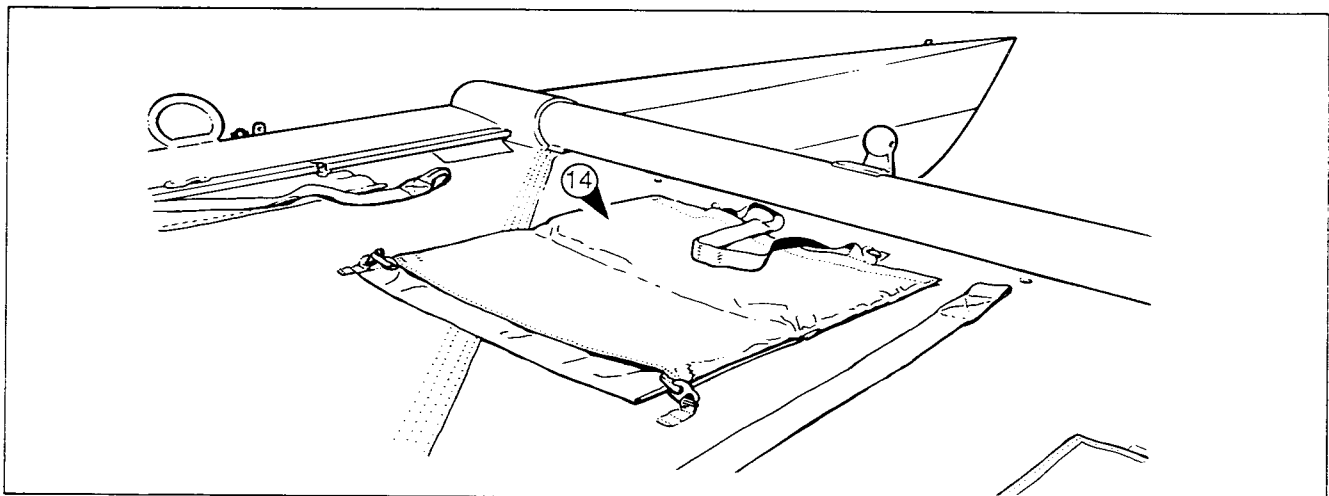

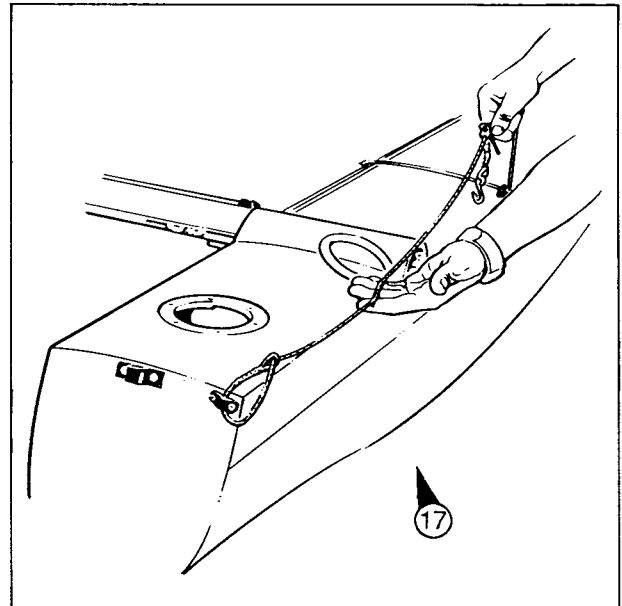
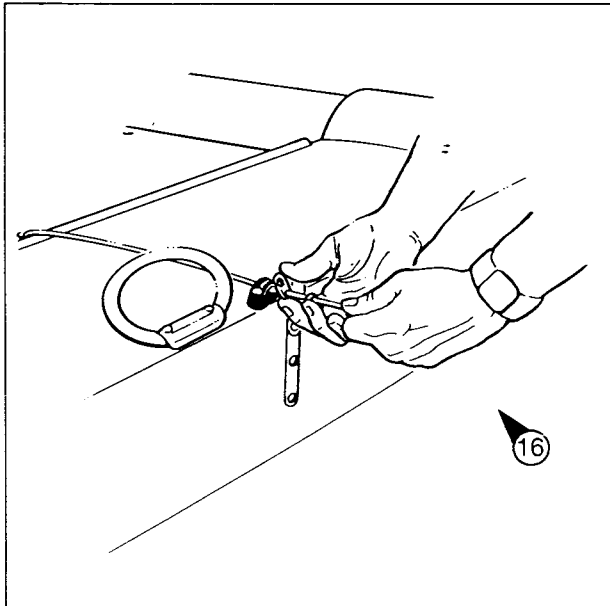

- \* Identify the trapeze restraining shock cords and feed them through the fair leads as shown (Fig 16)▲.
- \* Identify the trapeze restraining lines, Part AE, and secure them to the transom fair lead and restraining shock cord as shown (Fig 17)▼.

**RAISING THE MAST**

- \* Identify the main halyard, Part Z, remove the sheave wheel, insert halyard and replace. (Fig 18)▲.
- \* Slide the halyard down the luff groove using a knife or similar, and retrieve the lower end via the halyard roller finishing with a stopper knot as shown (Fig 19)▼.

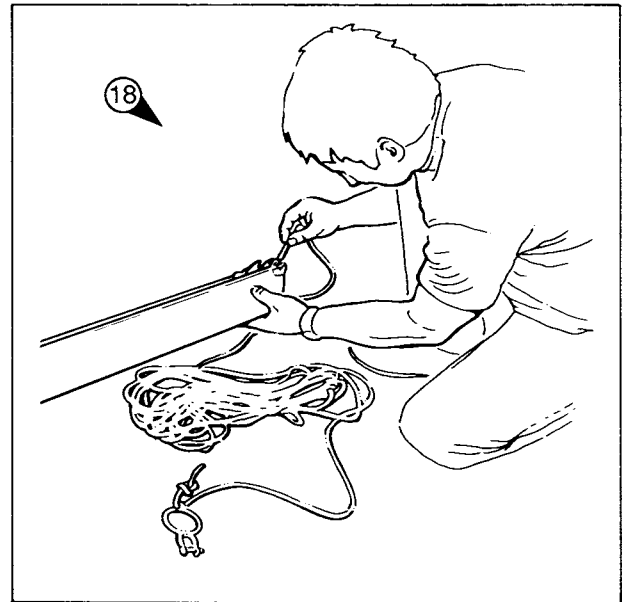
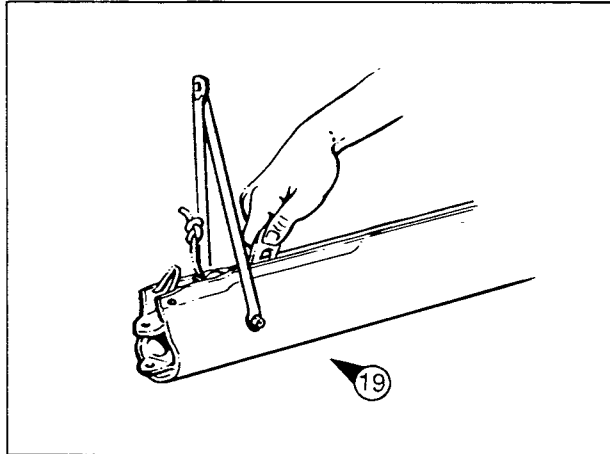

- \* Identify the jib halyard, Part AB, feed it through the jib halyard fairlead and down the luff groove similar to the main halyard finishing with a stopper knot (Fig 20)▼.

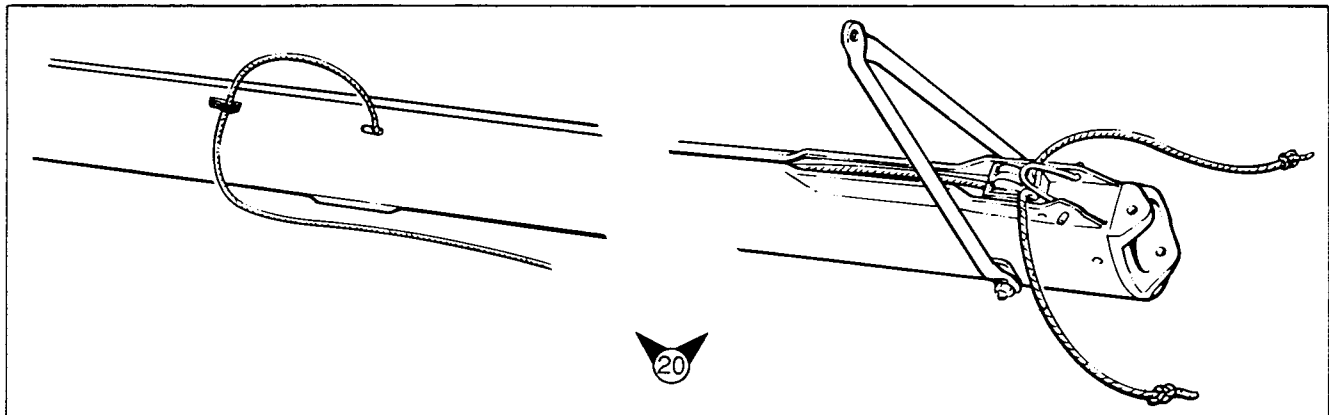



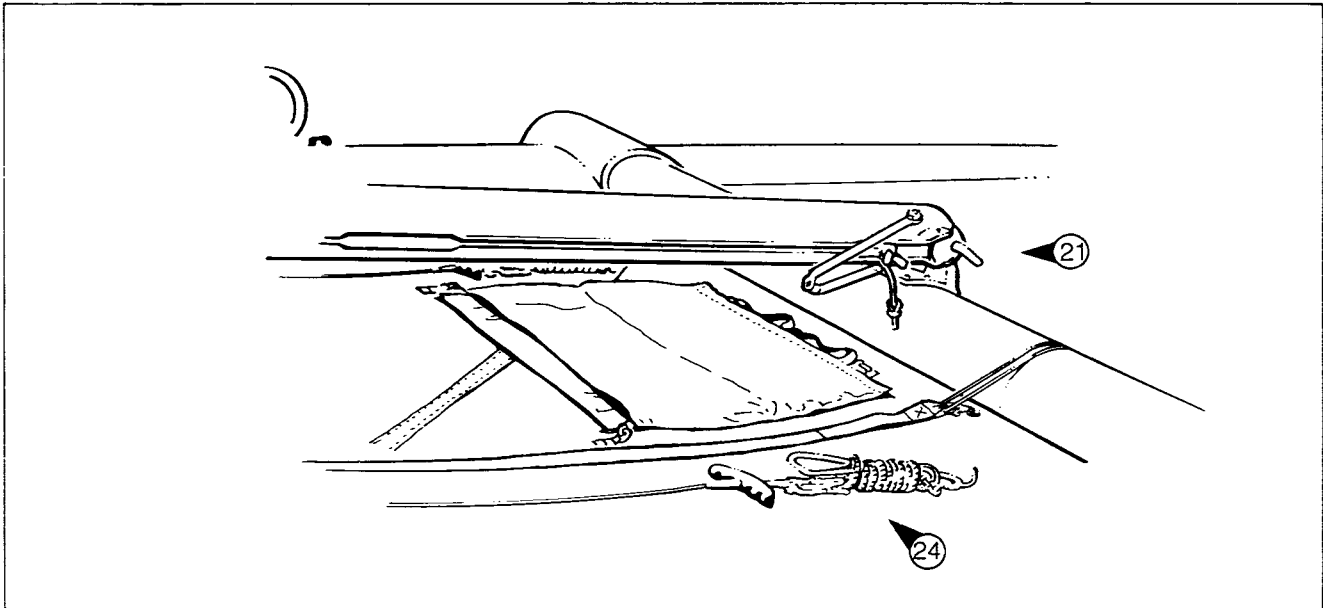

- \* Place the mast on the mast ball facing aft and use the mast pin to secure the heel as shown (Fig 21)▼. Lay the mast carefully on the rear beam using some suitable padding (ie transport packing or similar for protection).
- \* Identify the rigging wires, Part R, and connect the hound fitting to the mast as shown (Fig 22)▼. Check that the wine glass stamp is facing towards the top of the mast. Check that all the rigging shackles are secure, wired and taped.

- \* Carefully select the shroud wires and connect them to the shroud plates as shown (Fig 23)▼. The vernier shroud adjuster should be positioned approx. on hole 2 from the top. It is important to check that there are no twists or kinks in the rigging.
- \* Identify the trapeze wires and lay them alongside the mast (Fig 24)▲.

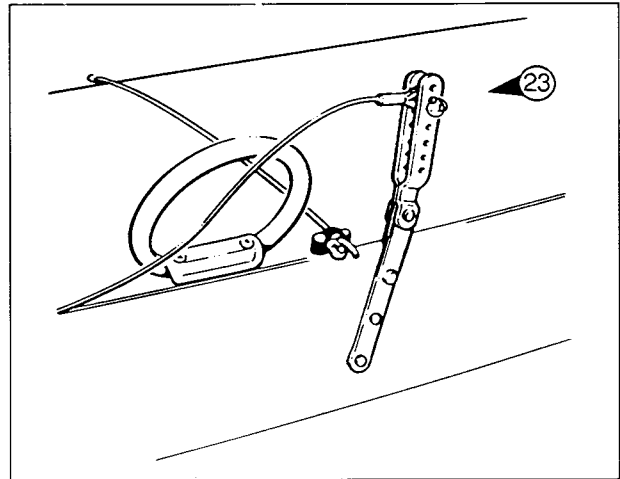
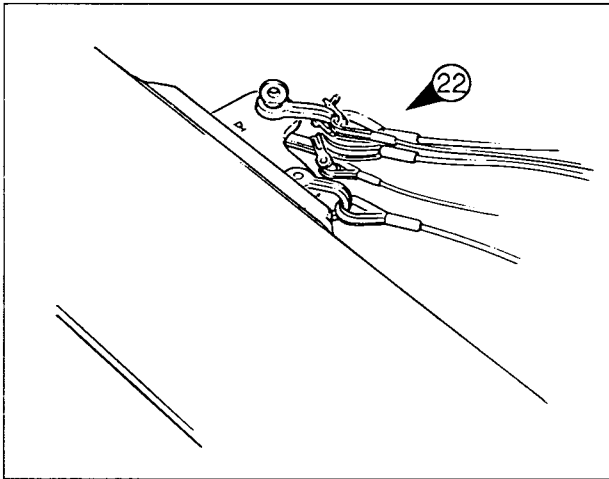

- \* Identify the forestay and feed the jib halyard through the halyard ring as shown (Fig 25)▼.

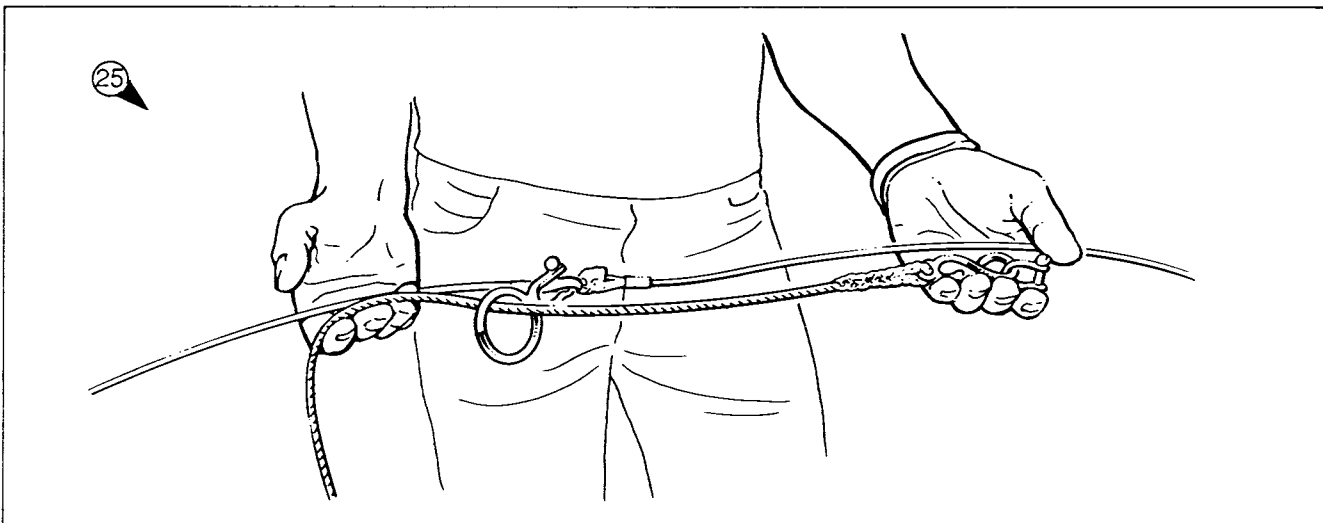

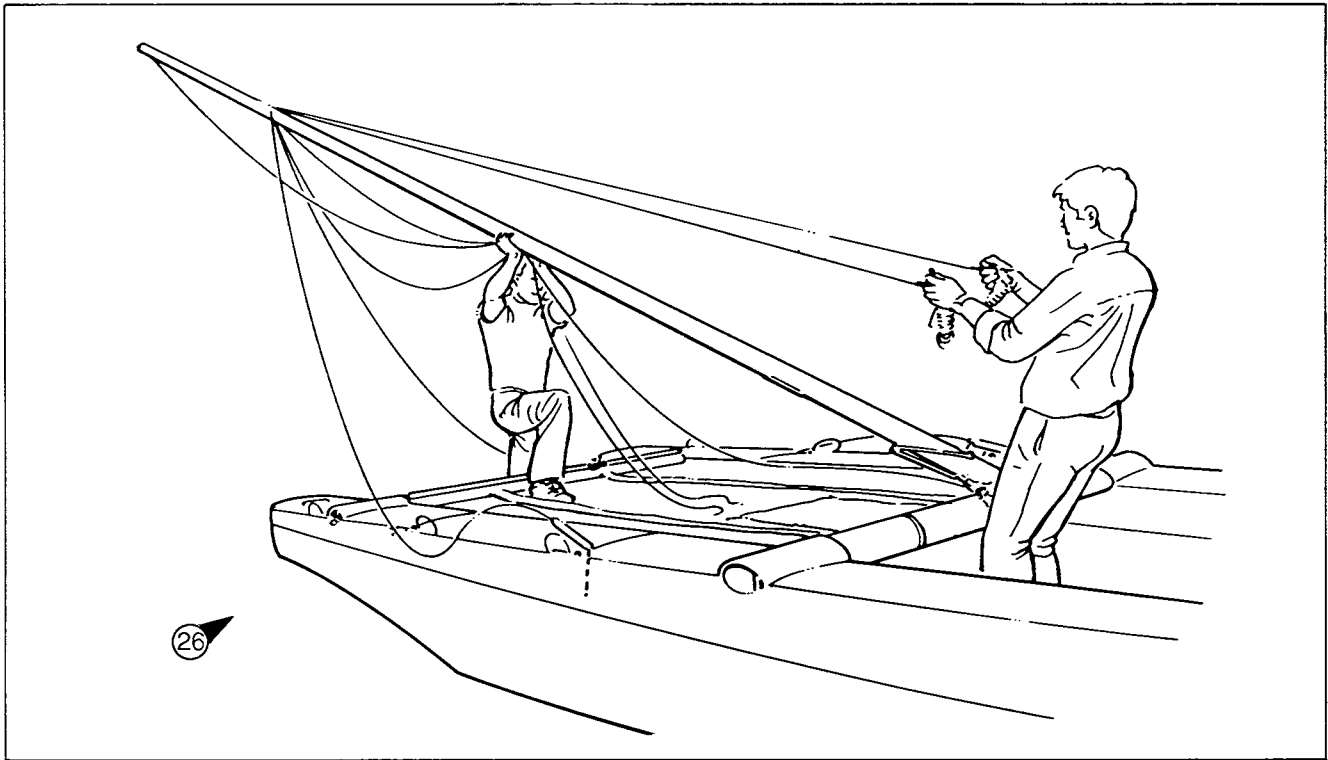

- \* Raise the mast by lifting it from the stern on to your shoulder and walk forward onto the trampoline (Fig 26)◀. This is easiest done when the boat is horizontal or facing slightly downhill. NB. Raising the mast can be done single handed but if two persons are present it is helpful to have someone holding the trapeze wires as extra precaution. Once the mast has been raised and restrained by the shroud wires, the mast pin should be removed allowing the mast to rotate.
- \* Identify the bridle wires and secure to the bow plate on each hull (Fig 26A)▶. Check that the loop of the wind indicator is facing aft.

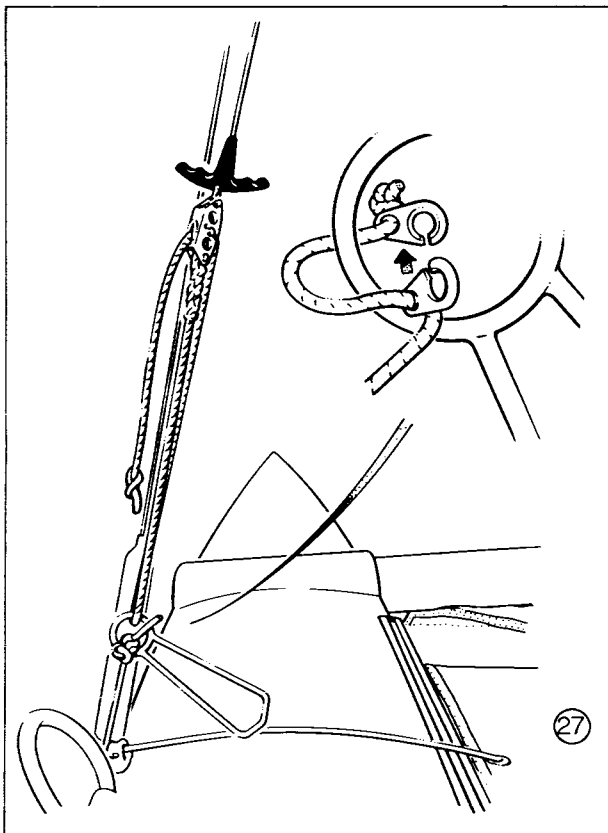
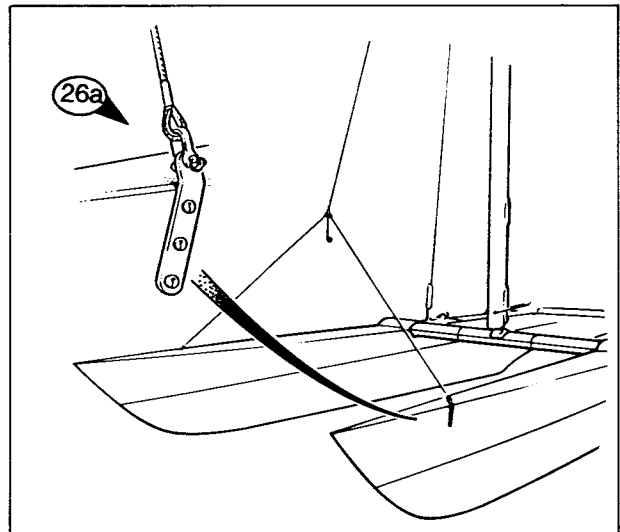

- \* Take each trapeze wire and secure it to the restraining shock cord as shown. Check that both trapeze wires are not tangled in any other rigging (Fig 27)◀

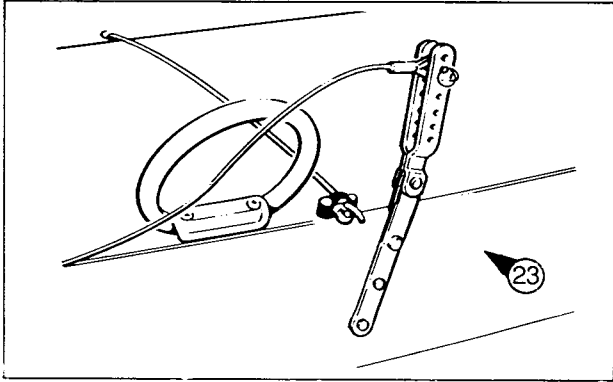

### RIG TENSION

The rig tension and mast rake on the Dart 18 gives a wide range of tuning options. A rope lacing line is supplied to allow mast rake adjustments (Fig 28) and the vernier shroud adjusters give rig tension (Fig 23).

Initially it is a good idea to sail with the mast in a vertical position, as shown, (Fig 29). At all times the rig tension should be such that the mast is free to rotate 180° across the boat (Fig 30). This is not possible if the rig tension is too tight.

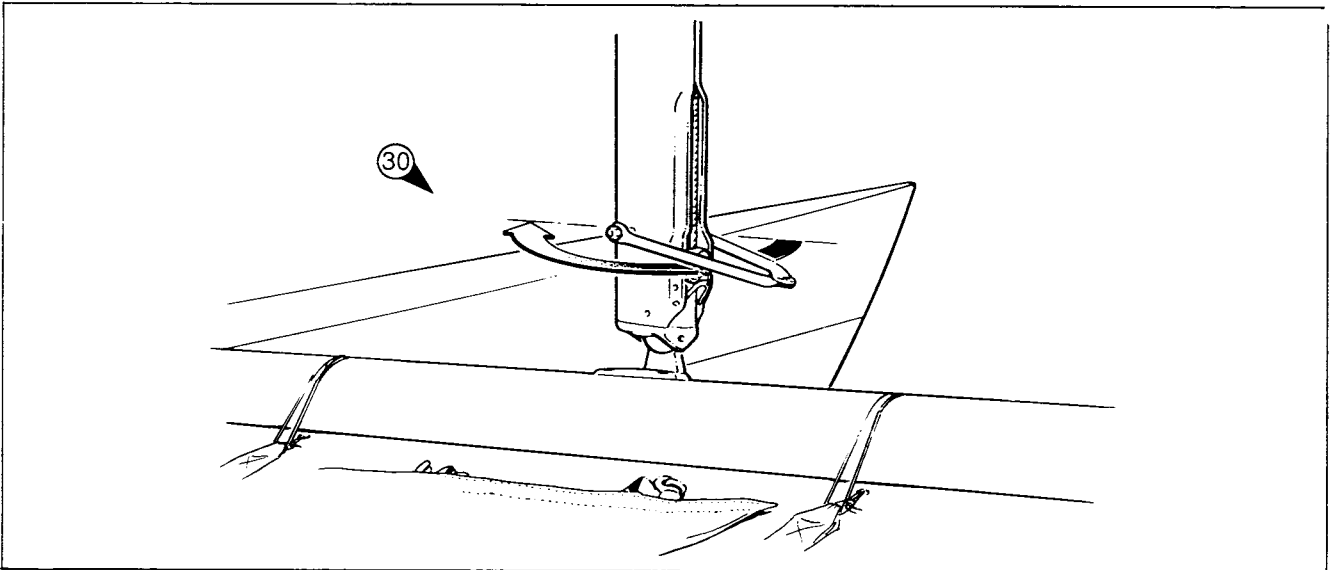
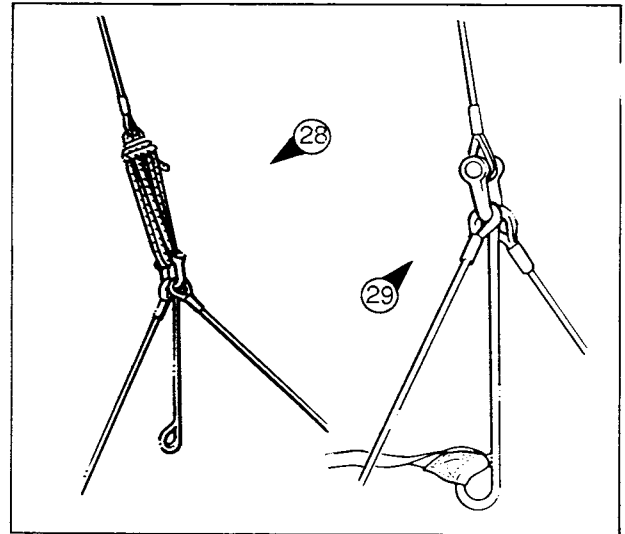

### ATTACHING THE SHEETS

- \* Select the traveller line, Part AD, and feed it through the traveller assembly and down through the centre slide on the rear beam as shown, (Fig 31) ▶
- \* Identify the main sheet assembly, Part U, and attach it to the traveller loop as shown, (Fig 32) ▶
- \* Tie the tail of the main sheet and end of the traveller line together with a suitable knot, (Fig 33) ▶

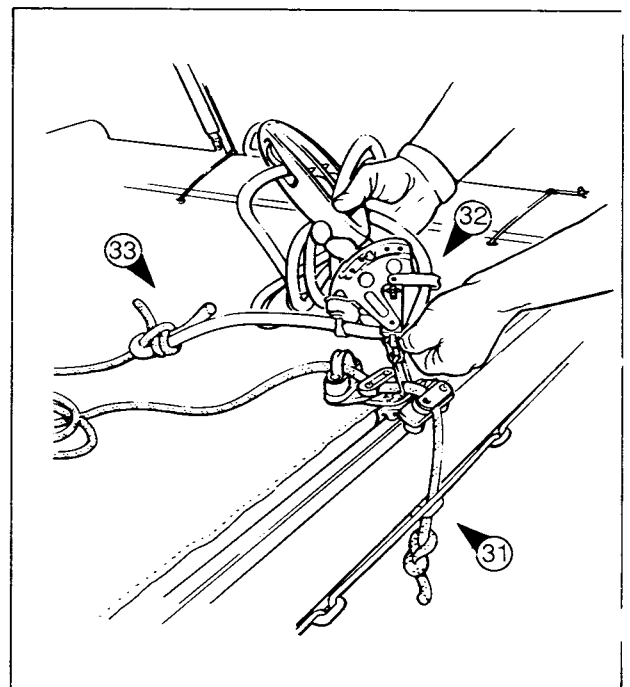

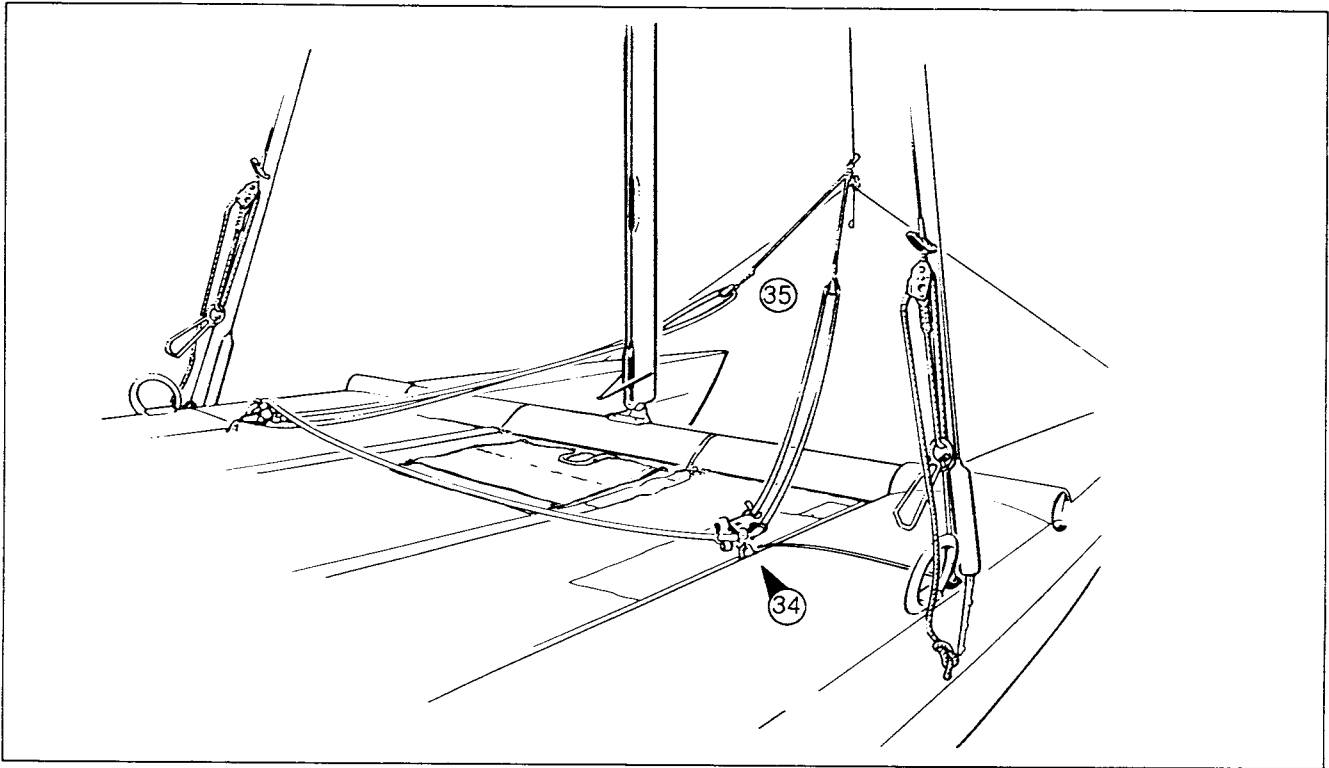

- \* Identify the jib blocks, Part X, and secure them to the jib fair leads as shown (Fig 34)▼.
- \* Identify the jib sheets, Part W, and thread them through the jib sheet system and jib stop as shown, (Fig 35)▲.
- \* Identify the main sail down haul, Part AA, and connect to the base of the mast as shown (Fig 36)▲.

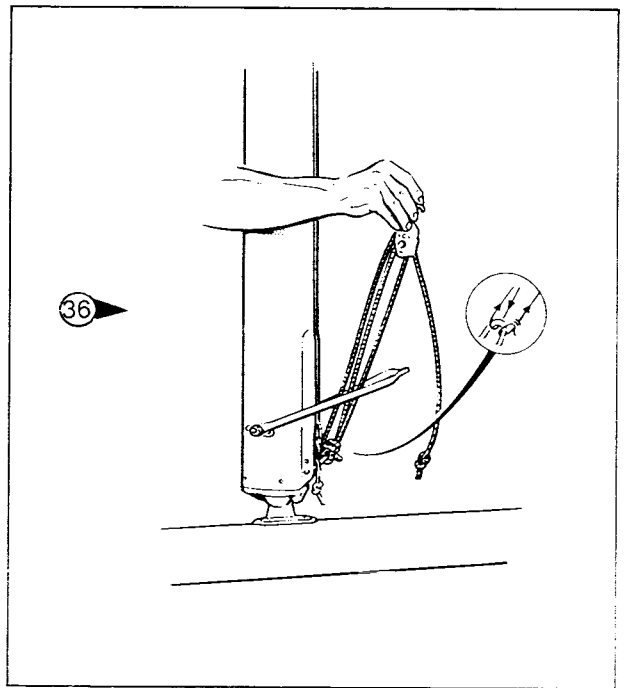

- \* Identify the down wind indicator, Part AJ, and secure it to the wind wand as shown (Fig 37)▲.
- \* Tape all split rings and pins for security using the supplied tape (Fig 38)▲.
- \* Select the two 'O' rings, Part C, and place them around the hatch rings. Place the hatch covers, Part D, in position and secure firmly with a screw action (Fig 39)▼. Make sure the hatch covers are not cross threaded.

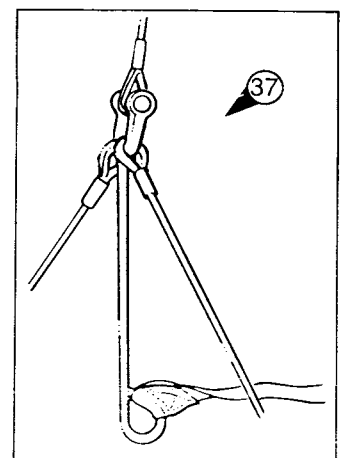
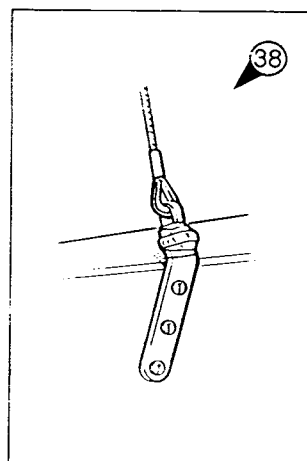
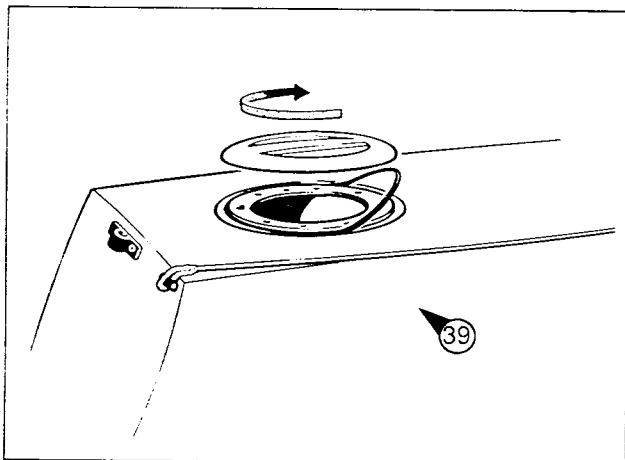

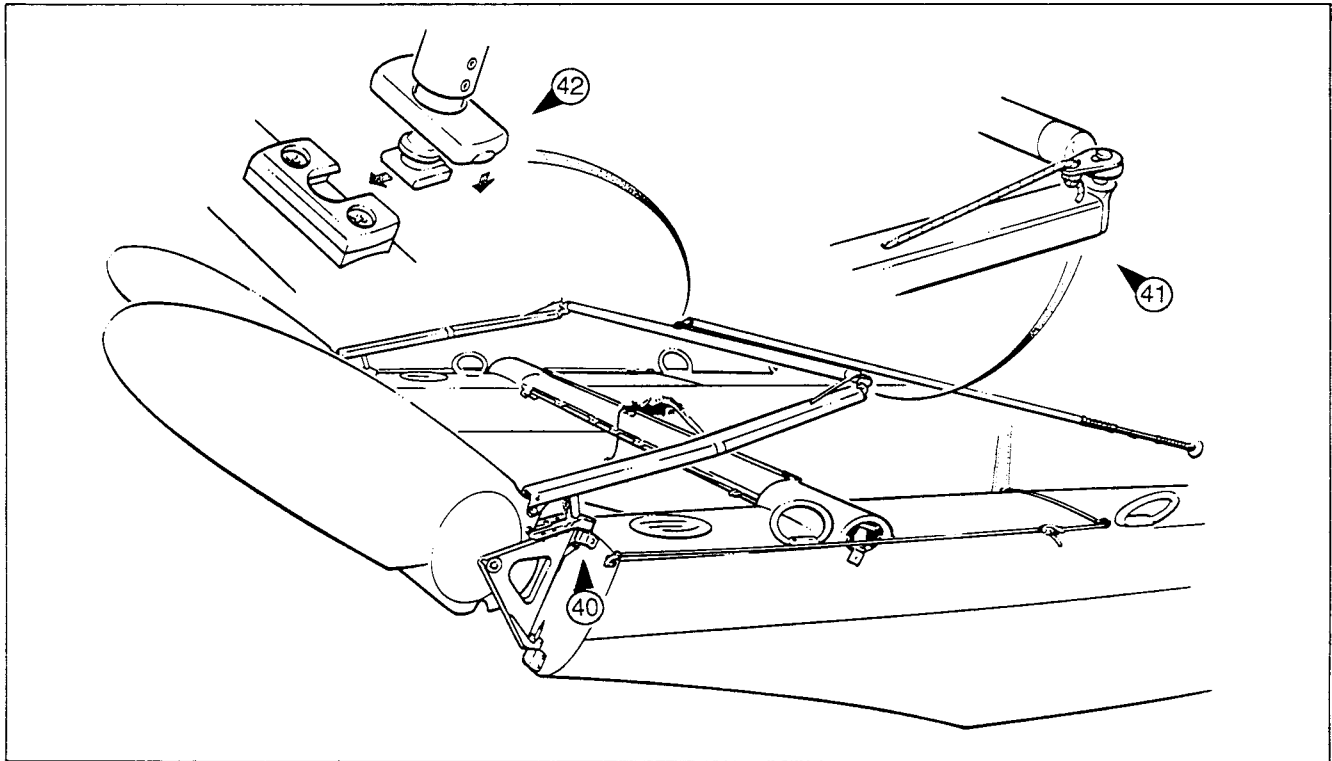

### CONNECTING THE RUDDER ASSEMBLY

- \* Identify the port and starboard rudders (left/right) and position on the hulls as shown (Fig 40) ◀. Make sure that the retaining clips lock correctly.
- \* Select the connecting bar, Part J, and place on the tiller pins securing with the clip as shown (Fig 41) ◀. NB. the black clip on the connecting bar should face upwards.
- \* Take the tiller extension, Part K, and clip it onto the connecting bar as shown (Fig 42) ▶.

### RAISING THE SAILS

- \* Lay out the main sail on a clean surface and insert the battens. No. 1 at the bottom - No. 9 at the top.
- \* Lace the batten ties through the batten and sail as shown, (Fig 43) ▶.
- \* Tension the battens using the thumb and fore-finger to create a small amount of curve in the batten pocket. Secure the tie with a reef knot and feed the tail ends down the side of the batten as shown, (Fig 44) ▶.

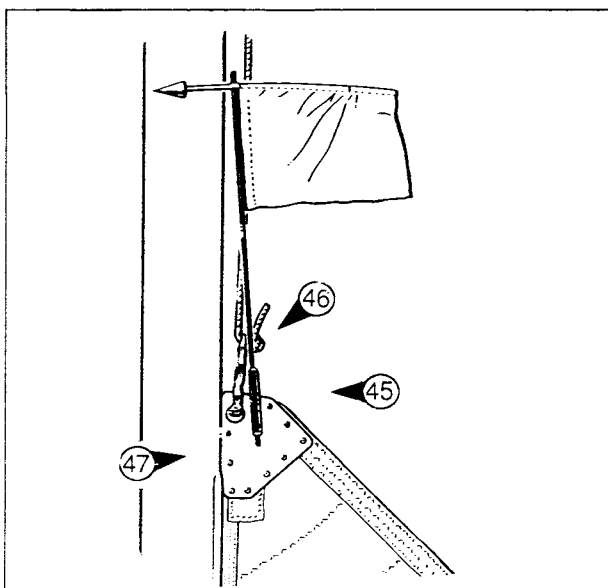
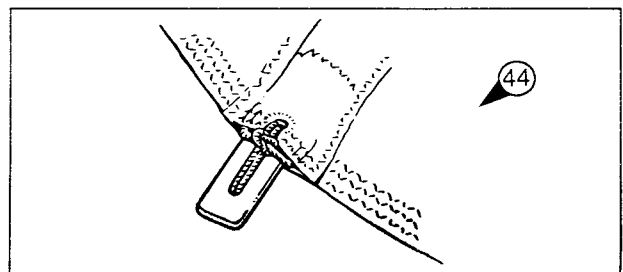
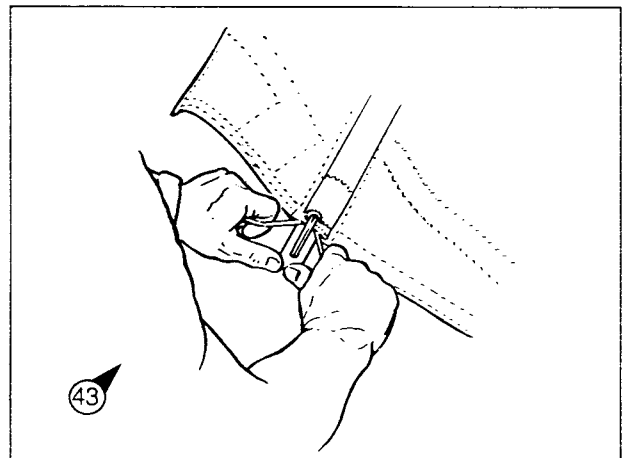

- \* Roll the sail from the foot and place on the trampoline with the luff facing forward.
- \* Position your boat with the bow facing into the wind.
- \* Clip the burgee (flag) onto the head board as shown (Fig 45) ◀
- \* Attach the halyard to the head of the sail with the halyard knot facing aft as shown (Fig 46) ◀
- \* Insert the luff of the sail into the mast groove opening approx. one metre from the mast base. (Fig 47) ◀

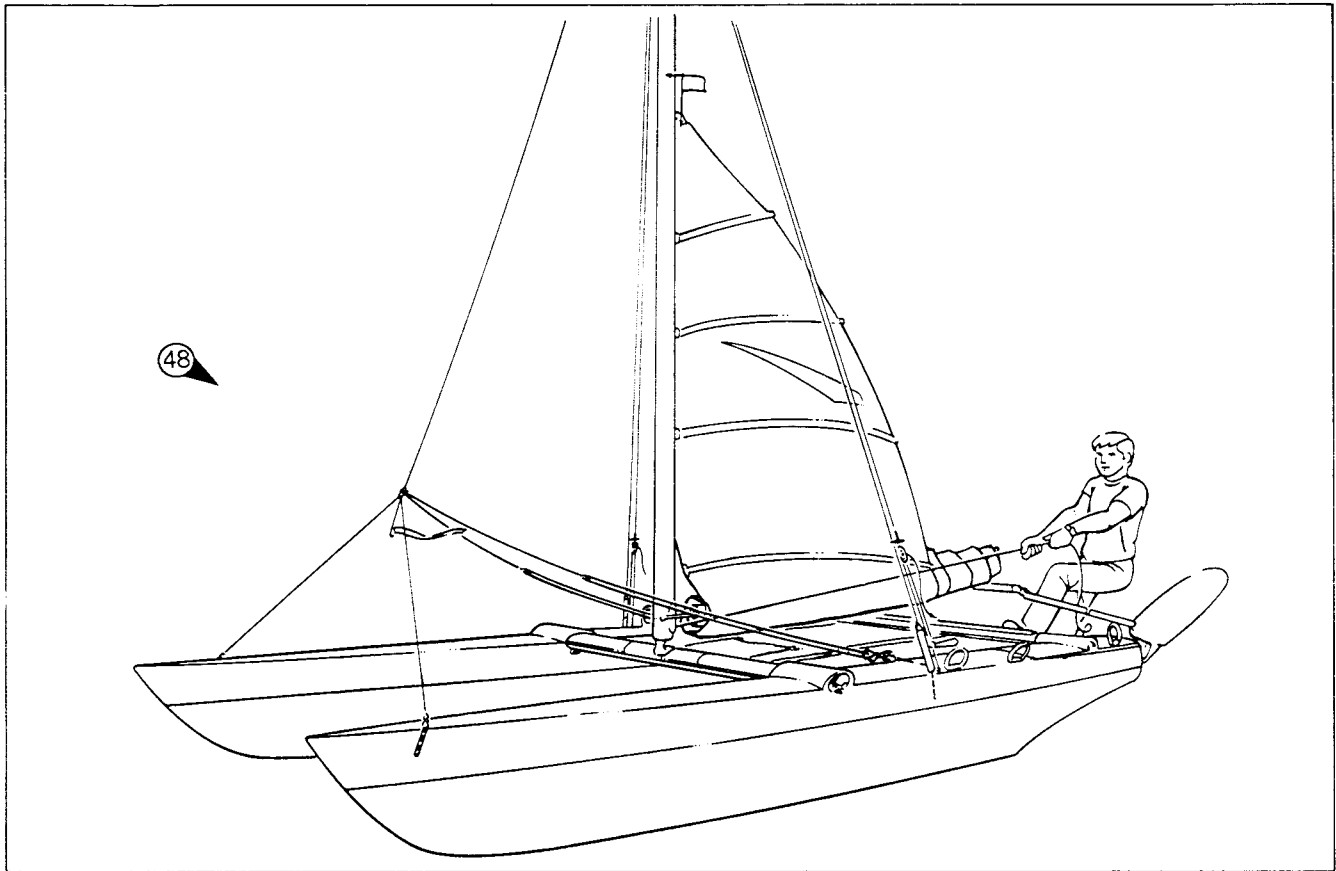

- \* Check that the halyard is running up the line of the mast groove, NOT AROUND THE MAST HOOK, and raise the sail by pulling the halyard where it exits from the base of the mast (Fig 48)▼. The mainsail is secured at the top of the mast by the halyard lock and the last 15cm of mainsail hoist should be achieved with a firm pull to ensure the locking ring is positioned over the hook as shown (Fig 49)▲
- \* Feed the tack of the sail down into the lower part of the luff groove and connect the mainsail down haul to the eye as shown (Fig 50)▼. At this point no tension should be applied to the sail luff. The main sheet assembly should only be connected to the clew eye when the boat is in the water and you are about to go sailing.
- \* Identify the spanner line, Part AF, feed it through the clew eye and clip to the mast spanner as shown (Fig 51 & 51A)▼. Store spare halyard in lower pocket of the trampoline bag.

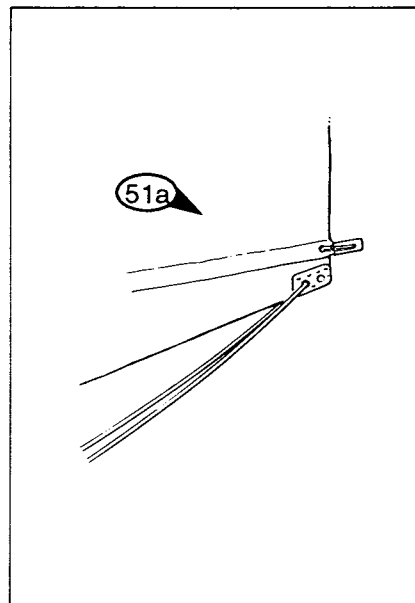
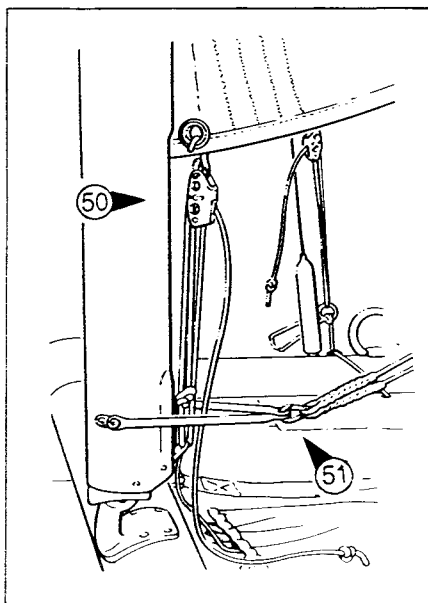
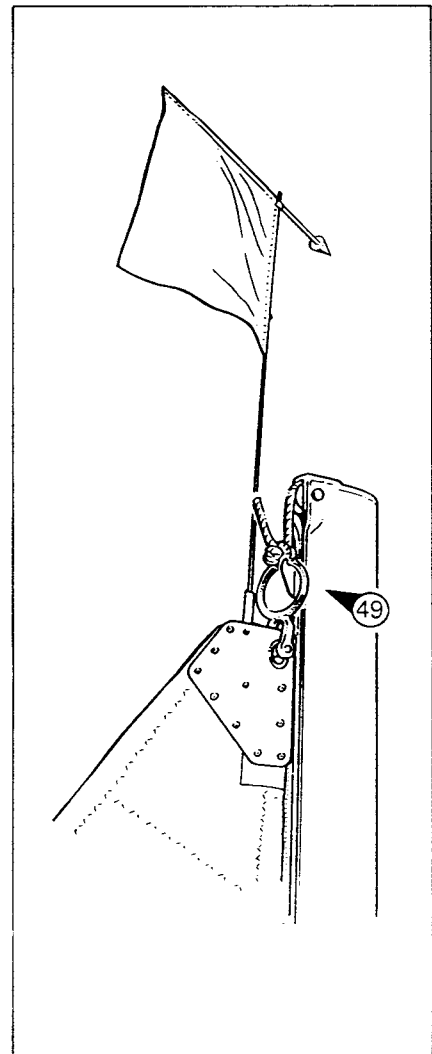

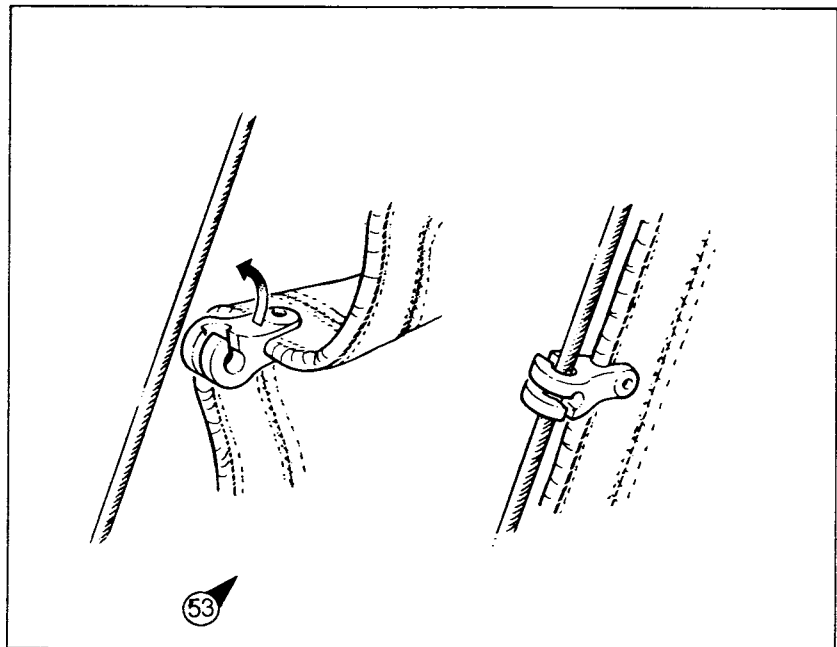
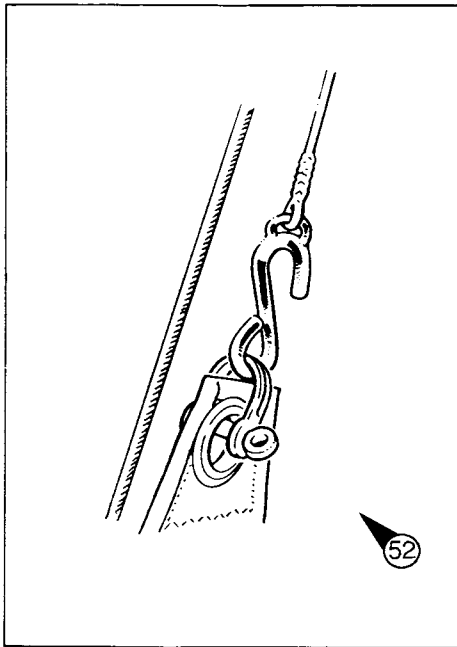

### RAISING THE JIB

- \* Unfurl the sail and connect the head to the halyard as shown (Fig 52)▲. It is important that the 'S' hook is positioned with its open edge facing aft.
- \* Hoist the sail from where the halyard exits at the base of the mast clipping each sail hank to the fore-stay using a push and turn action (Fig 53)▼.
- \* Hoist the sail through the lock ring and lower gently by tensioning the jib clew causing the hook to lock (Fig 54)▶.
- \* Coil the excess halyard and secure it in the under pocket of the trampoline bag.

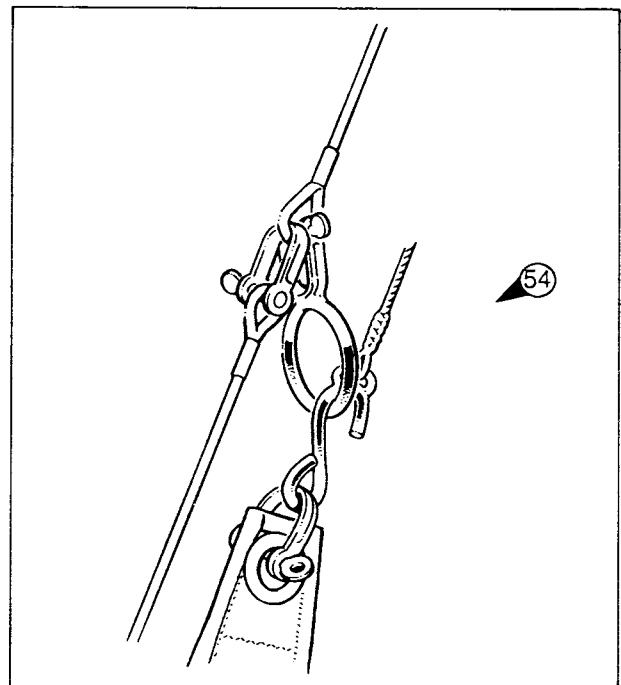

- \* Tension the luff of the jib using the down haul line as shown (Fig 55)▼. Care should be taken to ensure that the tension of the sail luff is no more than the tension of the fore-stay.
- \* Connect the jib sheet clip to the sail clew as shown (Fig 56)▲.
- \* Identify the paddle Part AL, and store it in the trampoline bag ready for use.

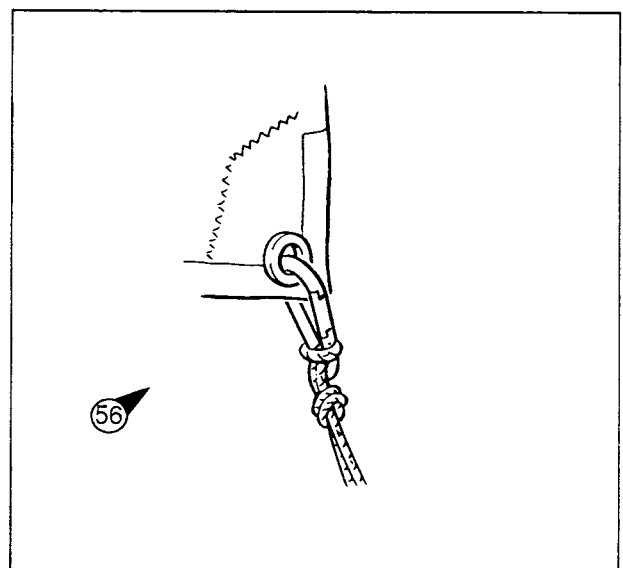
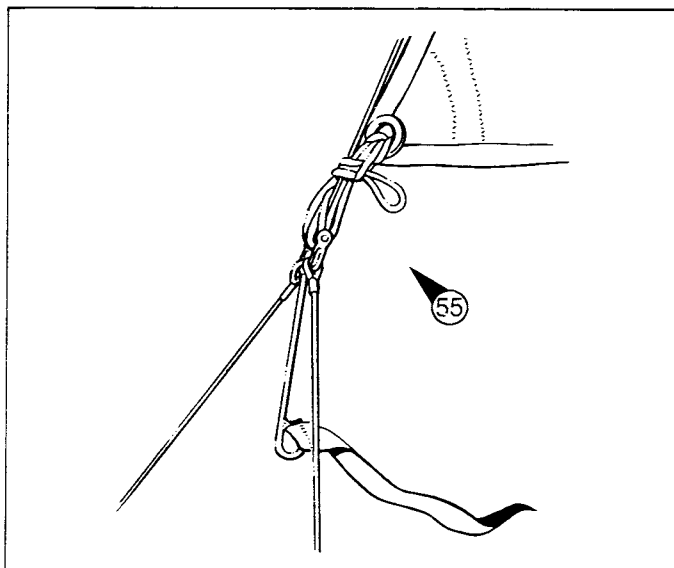

## YOUR FIRST SAIL

Your boat is now ready to sail but before you launch, it is a good idea to familiarise yourself with the boat's equipment, personal safety, and the technique of lifting and lowering the rudders.

## PERSONAL SAFETY

The DART 18 is an excellent compromise between FUN, SPEED AND SAFETY, we recommend you always wear suitable clothing and adequate buoyancy aid/life jacket when venturing afloat.

## RIGHTING IN THE EVENT OF CAPSIZE

The DART 18 can be righted from a total inversion or a 90° knock down. Good use should be made of the main halyard or jib sheets as convenient righting lines. NB. Catamarans can only be righted when the mast is pointing towards the wind. Further details of the correct righting procedure of catamarans is available in the Catamaran Book.

## LIFTING AND LOWERING RUDDERS

The rudders may be lowered independently.

To Lower a rudder lift the tiller arm via the connecting bar and gently push backwards (Fig 57) until the lock roller drops into the lower slot of the rudder blade.

To lift the rudders, hold the connecting bar close to the tiller end, lift and pull in a scoop action (Fig 58) allowing the roller to follow the rudder cam into the upper rudder slot. NB. It is a good idea to lift and lower rudders independently to ensure some steerage control whilst sailing on and off the beach.

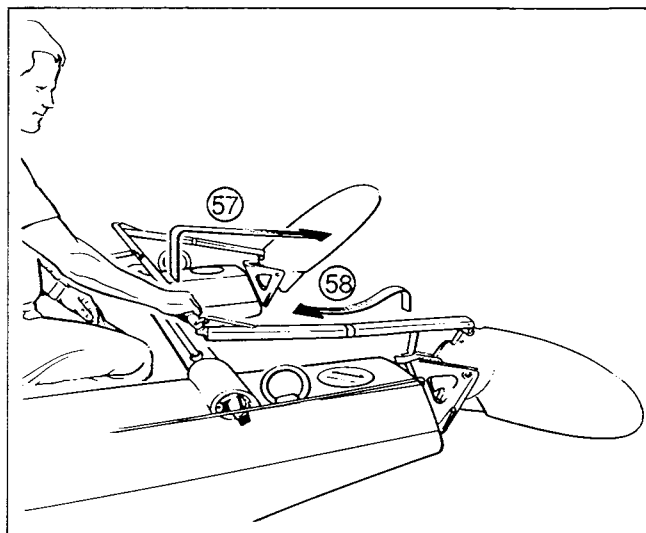

## JIB AND MAIN SHEET BLOCKS

All ratchet blocks can be adjusted to allow quick release of sheets from the jamming cleats (Fig 59) there is also an ON/OFF ratchet facility for sailing in strong winds (Fig 60) ▶

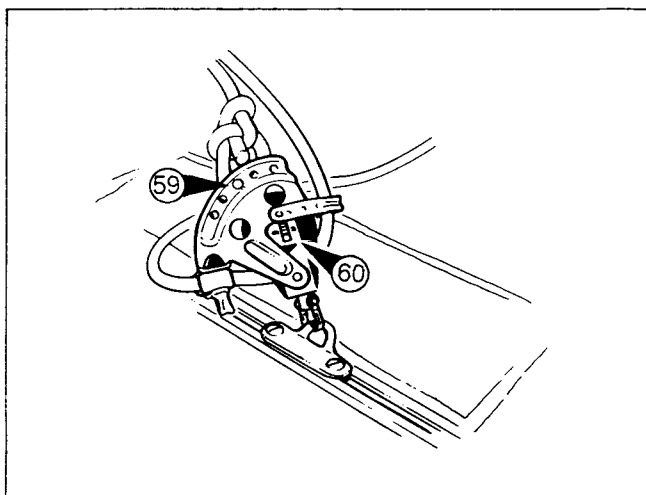

## LOWERING THE MAIN SAIL

To lower the main sail it is necessary to detach the halyard ring from the mast head lock. This sequence is simple but needs to be accurately followed.

1. Place the boat **head to wind**.
2. Disconnect the spanner control line.
3. Disconnect the main sail down haul and remove the lower sail luff from the mast groove.
4. Pull the halyard firmly to lift the halyard ring off the hook, **retain the tension**.
5. Turn the mast to port (left).
6. Release the halyard and pull the tack of the main sail downwards, make sure the mast is still rotated to port.
7. Once the sail has been pulled down past the hook, the mast can be released and the sail lowered in a normal fashion.
8. It is a good idea to roll the sail as it is lowered to prevent it from being blown away.

## LOWERING THE JIB

1. Release the jib down haul line.
  2. Raise the jib via its halyard.
  3. Lower the jib by pulling down on the sail tack.
- NB. This action should be carried out in a quick, smooth action, ie up/down so that the jib hook falls through the lock ring.



## ACCESSORIES

### LAUNCHING TROLLEY

The launching trolley can be transported, assembled or broken down (two simple bolts secure the cup to the main shaft). To position the trolley under the hulls, place the trolley across the bows and lift the bows to allow the trolley room to slide under the keels. Its final position should be at the boat's balance point which is approximately between the main beam and the shroud plates.

NB. It is inadvisable to leave the boat in this position for any length of time as it can easily be blown off the trolley given sufficient wind.

### ROAD TRAILER

The standard road trailer available for the DART 18 allows you to tow your catamaran fully made up. Once the mast has been lowered, the hulls can be slid onto the trailer (bow first) with the lighting board/mast support clipped onto the rudder fittings. The hulls and mast should then be secured with suitable ties.

NB. Before towing the trailer, check that the weight on the tow hitch is acceptable and that the position of the hulls is such that they cannot catch the side of the towing vehicle when turning. The trailer has facilities for adjustment if required.

### BOAT AND HULL COVERS

These are available for all Dart catamarans. Their use will help protect your craft and prolong its quality finish.

## GENERAL MAINTENANCE AND SERVICE

### WEEKLY:

1. Your boat should always be tied down securely to ground fixings when not in use. The sails should be stored dry when possible.
2. Any water which has accumulated in the hull during sailing should be removed using the supplied sponge.

### MONTHLY:

1. Ropes and rigging should be checked periodically for wear or damage.
2. All moving parts such as jamming cleats and blocks should be lubricated lightly with WD40 or something similar. NB. This includes the lifting mechanism of the rudder system but not the rollers themselves.
3. It is important that you regularly check that shackle fixings are secured at the hound fitting and that all clevice pins/rings are securely taped.

### GEL COAT REPAIR

Should you damage the gel coat surface of your boat, you should repair it as soon as possible. The correct gel coat colour can be ordered through your DART agent.

1. Sand back the damaged or flaking gel coat until a solid area is produced. Make sure the area is clean and there are no sharp edges, (Fig 61) ▶
2. Mix the gel coat with approximately 2% of hardener and apply using a fine artist's brush or similar, (Fig 62) ▶
3. Cover the area with cellophane and allow to dry, (Fig 63) ◀
4. Brushes and equipment should be washed out in acetone if required further.
5. When dry, carefully remove cellophane and sand surface with wet and dry sand paper until it blends in with the original area, (Fig 64) ▼
6. Finally polish the area using a fibre glass rubbing compound or similar.

NB. If substantial damage is sustained to your craft, you should take it to your nearest authorised DART repair centre or contact your nearest DART agent.

### END OF SEASON

1. At the end of each season it is a good idea to check your boat thoroughly for signs of damage or wear.
2. Damage or worn parts should be replaced using DART parts' identification system.
3. The hull should be washed down with fresh water and a protective cover placed over it.
4. Spares and rigging should be washed thoroughly, dried and placed in a protective area.
5. Sails should be thoroughly washed, dried, checked and stored in a dry place.
6. Road trailer and launching trolley should be washed, checked and greased where necessary.

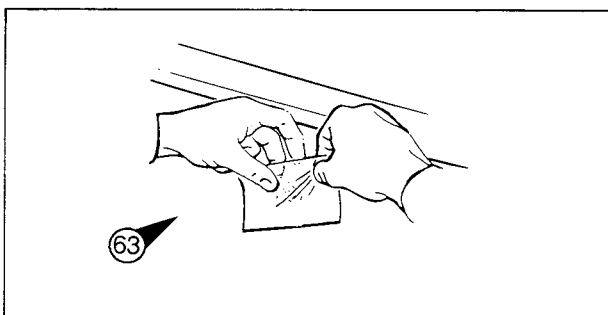
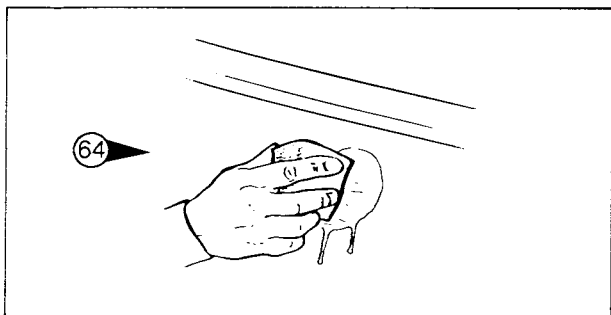
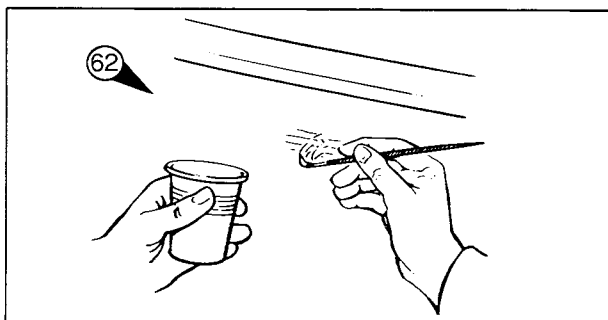
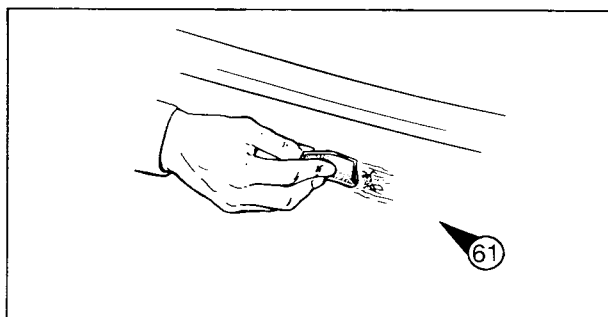

## **BASIC SAFETY AFLOAT : By the CAT CLINIC**

### **Before you go sailing:**

1. Check you are wearing suitable clothing and safety equipment for the conditions and time of year.  
NB Always wear a buoyancy aid or life jacket.
2. Make sure a third party knows where you are sailing and how many there are in your group.
3. Check the weather forecast: radio, television or coastguards.
4. Check the time of high and low tides, if applicable.
5. Seek advice on local conditions when sailing in a new area.
6. Check the condition of your craft.
7. Beware of overhead cables.

### **On the water:**

1. Conform to the sailing rules of the road.
2. Look out for changing weather conditions.
3. Never sail beyond your ability or that of your crew.
4. Understand and be competent in the sailing and righting techniques of your craft.

### **The end of the day:**

1. Check the condition of your craft.
2. Secure your craft to its parking berth.
3. Advise any third party of your safe return.
4. Look forward to your next successful sailing trip.

